



# Xerox<sup>®</sup> Simplex Combo Scanner

Scanner User Guide for Mac OSX<sup>®</sup>.

© 2018 Xerox Corporation. All rights reserved. Xerox® and Xerox and Design® are registered trademarks of Xerox Corporation in the United States and/or other countries and are used under license from Xerox Corporation. Visioneer is a trademark licensee of Xerox®. BR21564

Content © 2018 Visioneer, Inc. All rights reserved. The Visioneer brand name is a registered trademark of Visioneer, Inc.

Reproduction, adaptation, or translation without prior written permission is prohibited, except as allowed under the copyright laws. Copyright protection claimed includes all forms of matters of copyrightable materials and information now allowed by statutory or judicial law or hereinafter granted, including without limitation, material generated from the software programs which are displayed on the screen such as styles, templates, icons, screen displays, looks, etc.

Document Version: 05-0957-100 (August 2018)

Adobe®, Adobe® Acrobat®, Adobe® Reader®, and the Adobe® PDF logo are registered trademarks of Adobe Systems Incorporated in the United States and/or other countries.

Post-It® is a registered trademark of 3M in the United States and/or other countries.

Mac®, Mac OS®, and OS X® are trademarks of Apple Inc., registered in the U.S. and other countries.

ZyINDEX is a registered trademark of ZyLAB International, Inc. ZyINDEX toolkit portions, Copyright © 1990-1998, ZyLAB International, Inc.

TWAIN™ is a trademark of TWAIN Working Group.

Intel® and Pentium® are trademarks of Intel Corporation in the United States and/or other countries.

Universal Serial Bus is a trademark of USB Implementers Forum, Inc. (USB-IF).

Kensington® is a registered trademark of ACCO Brands Corporation.

All other products mentioned herein may be trademarks of their respective companies and are hereby acknowledged.

Changes are periodically made to this document. Changes, technical inaccuracies, and typographic errors will be corrected in subsequent editions. Information is subject to change without notice and does not represent a commitment on the part of Visioneer.

The software described is furnished under a licensing agreement. The software may be used or copied only in accordance with the terms of such an agreement. It is against the law to copy the software on any medium except as specifically allowed in the licensing agreement. No part of this document may be reproduced or transmitted in any form or by any means, electronic or mechanical, including photocopying, recording, or information storage and retrieval systems, or translated to another language, for any purpose other than the licensee's personal use and as specifically allowed in the licensing agreement, without the express written permission of Visioneer.

**Restricted Rights Legend**

Use, duplication, or disclosure is subject to restrictions as set forth in contract subdivision (c)(1)(ii) of the Rights in Technical Data and Computer Software Clause 52.227-FAR14. Material scanned by this product may be protected by governmental laws and other regulations, such as copyright laws. The customer is solely responsible for complying with all such laws and regulations.

# Table of Contents

<b>1-Safety</b> .....	<b>1-1</b>
Safety Introduction .....	1-1
Operational Safety Information.....	1-1
Electrical Information.....	1-2
Warning - Electrical Safety Information .....	1-2
Electrical Supply .....	1-2
Disconnect Device .....	1-3
Emergency Power Off .....	1-3
Maintenance Information.....	1-3
Product Safety Certification .....	1-3
Environmental Health and Safety Contacts.....	1-4
<b>2-Welcome</b> .....	<b>2-1</b>
What's in the Box.....	2-1
System Requirements.....	2-2
Documentation .....	2-2
Xerox® Simplex Combo Scanner Features .....	2-3
<b>3-Assemble the Scanner</b> .....	<b>3-1</b>
Connect the Power Cord.....	3-2
<b>4-Installation</b> .....	<b>4-1</b>
Installing the Scanner Driver .....	4-4
Connect the USB Cable and Turn on the Power.....	4-6
Install the Visioneer Scan Utility.....	4-6
Installing Additional Applications.....	4-6
View the User Guides.....	4-7
Register Your Scanner.....	4-8
<b>5-Loading Documents to Scan</b> .....	<b>5-1</b>
Scanning from the Automatic Document Feeder (ADF) .....	5-1
Supported Document Types .....	5-1
Documents to Avoid Scanning.....	5-1
Unsupported Document Types.....	5-2
Preparing Documents for Scanning.....	5-2
Loading Documents.....	5-3
Scanning from the Flatbed Glass .....	5-3
Supported Document Types .....	5-3
Loading Documents.....	5-3
Scanning Interfaces .....	5-4

<b>6-Maintenance</b> .....	<b>6-1</b>
Safety Precautions.....	6-1
Clearing Paper Jams.....	6-2
Cleaning the Scanner.....	6-3
Cleaning Inside the Automatic Document Feeder .....	6-3
Cleaning the Scanner Glass.....	6-4
Replacing the ADF Pad Assembly.....	6-5
Troubleshooting.....	6-7
Error Light Troubleshooting Codes.....	6-9
Xerox® Simplex Combo Scanner Specifications.....	6-10
Xerox® Simplex Combo Scanner Parts List .....	6-11
<b>7-Appendix A: Regulatory Information</b> .....	<b>7-1</b>
Basic Regulations.....	7-1
United States (FCC Regulations).....	7-1
European Union.....	7-1
Turkey (RoHS Regulation) .....	7-2
Copy Regulations.....	7-2
United States .....	7-2
Canada .....	7-3
Other Countries.....	7-4
<b>8-Appendix B: Compliance Information</b> .....	<b>8-1</b>
Product Recycling & Disposal.....	8-1
USA & Canada.....	8-1
European Union.....	8-1
ENERGY STAR for the USA.....	8-1

# 1. Safety

## Safety Introduction

### Notices and Safety

Please read the following instructions carefully before operating the machine and refer to them as needed to ensure the continued safe operation of your machine.

Your Xerox® product and supplies have been designed and tested to meet strict safety requirements. These include safety agency evaluation and certification, and compliance with electromagnetic regulations and established environmental standards.



The safety and environment testing and performance of this product have been verified using Xerox® materials only. Unauthorized alterations, which may include the addition of new functions or connection of external devices, may impact the product certification. Please contact your Xerox representative for more information.

## Operational Safety Information

Your Xerox® equipment and supplies have been designed and tested to meet strict safety requirements. These include safety agency examination, approval, and compliance with established environmental standards.

To ensure the continued safe operation of your Xerox® equipment, follow these safety guidelines at all times:

### Do these:

- Always follow all warnings and instructions that are marked on or supplied with the equipment.
- Always use materials specifically designated for this product, the use of other materials may result in poor performance and create a hazardous situation. Do not use aerosol cleaners, they may be explosive and flammable under certain conditions.
- Always exercise care when moving or relocating equipment.
- Always locate the machine on a solid support surface that has adequate strength to support the weight of the machine.
- Always locate the machine in an area that has adequate ventilation and room for servicing.
- Always unplug this equipment from the electrical outlet before cleaning.

**Note:** Your Xerox® machine is equipped with an energy saving device to conserve power when the machine is not in use. The machine may be left on continuously.

### Do not do these:

- Never use a ground adapter plug to connect the equipment to a power outlet that lacks a ground connection terminal.

- Never attempt any maintenance function that is not specifically described in this documentation.
- Never remove covers or guards that are fastened with screws. There are no operator serviceable areas within these covers.
- Never locate the machine near a radiator or any other heat source.
- Never override or “cheat” any of the electrical or mechanical interlock devices.
- Never place this equipment where people might step on or trip on the power cord.



**Caution: This device is not intended for use in the direct field of view at visual display workplaces**

To avoid incommoding reflections at visual display workplaces this device must not be placed in the direct field of view.

## Electrical Information

### WARNING - ELECTRICAL SAFETY INFORMATION

1. The power receptacle for the machine must meet the requirements stated on the data plate on the rear of the machine. If you are not sure that your electrical supply meets the requirements, please consult your local power company or an electrician for advice.
2. The socket outlet shall be installed near the equipment and shall be easily accessible.
3. Use the power cable that is supplied with your machine. Do not use an extension cord or remove or modify the power cord plug.
4. Plug the power cable directly into a correctly grounded electrical outlet. If you are not sure whether or not an outlet is correctly grounded, consult an electrician.
5. Do not use an adapter to connect any Xerox® equipment to an electrical outlet that lacks a ground connection terminal.
6. Do not place this equipment where people might step or trip on the power cable.
7. Do not place objects on the power cable.
8. Do not override or disable electrical or mechanical interlock devices.
9. Do not push objects into slots or openings on the machine. Electrical shock or fire may result.

### ELECTRICAL SUPPLY

- This product shall be operated from the type of electrical supply indicated on the product's data plate label. If you are not sure that your electrical supply meets the requirements, please consult your local power company for advice.



- Always connect equipment to a correctly grounded power outlet. If in doubt, have the outlet checked by a qualified electrician.



**WARNING: This equipment must be connected to a protective earth circuit**

This equipment is supplied with a plug that has a protective earth pin. This plug will only fit into an earthed electrical outlet. This is a safety feature. If you are unable to insert the plug into the outlet, contact your electrician to replace the outlet.

**DISCONNECT DEVICE**

The power cable is the disconnect device for this equipment. It is attached to the side of the machine as a plug-in device. To remove all electrical power from the equipment, disconnect the power cable(s) from the electrical outlet.

## Emergency Power Off

If any of the following conditions occur, turn off the machine immediately and disconnect the power cable(s) from the electrical outlet(s).

- The equipment emits unusual odors or makes unusual noises.
- The power cable is damaged or frayed.
- A wall panel circuit breaker, fuse, or other safety device has been tripped.
- Liquid is spilled into the machine.
- The machine is exposed to water.
- Any part of the machine is damaged.

## Maintenance Information

1. Any operator product maintenance procedures will be described in the user documentation supplied with the product.
2. Do not carry out any maintenance on this product which is not described in the customer documentation.
3. Do not use aerosol cleaners. The use of cleaners that are not approved may cause poor performance of the equipment, and could cause a dangerous condition.
4. Use supplies and cleaning materials only as directed in this manual.
5. Do not remove covers or guards that are fastened with screws. There are no parts behind these covers that you can maintain or service.
6. Do not perform any maintenance procedures unless you have been trained to do them by an authorized local dealer or unless a procedure is specifically described in the user manuals.

## Product Safety Certification

This product is certified by the following Agency using the Safety standards listed:

Standard
UL60950-1 (USA)
CSA 22.2 No. 60950-1 (Canada)
IEC 60950-1



## Environmental Health and Safety Contacts

### Contact Information

For more information on Environment, Health, and Safety in relation to this Xerox® product and supplies, please contact the following customer help lines:

<b>North America &amp; Europe (Phone):</b> 1-800-ASK-XEROX
--

<b>North America &amp; Europe (Fax):</b> 1-585-422-8217
---

## 2. Welcome

Your new Xerox® scanner can quickly scan stacks of documents with the Automatic Document Feeder (ADF), or single pages on the Flatbed glass.

### What's in the Box

Before proceeding, check the contents of the box. If items are missing or damaged, contact the dealer where you purchased the scanner.

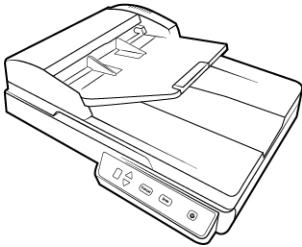

Xerox® Simplex Combo Scanner



Quick Install Guide



Technical Support Card



Warranty Card



USB Cable



Power Supply

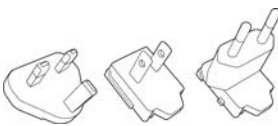

Power adapter plugs



Installation Disc

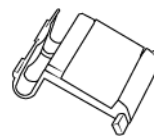

Spare ADF Pad

## System Requirements

	Minimum	Recommended
Processor	2Ghz Intel Core 2 Duo	2.6 Ghz Intel Core i5
Optical Drive	DVD Rom drive capable of reading Dual layer DVDs	DVD Rom drive capable of reading Dual layer DVDs
USB Port	An available Universal Serial Bus (USB) 2.0 port	An available Universal Serial Bus (USB) 2.0 port
OS	Apple® Mac OS X® operating system (10.9 – 10.13)	Apple® Mac OS X® operating system (10.9 – 10.13)
RAM	2 gigabyte (GB) of internal memory (RAM)	4 gigabyte (GB) of internal memory (RAM)
Hard Drive Space	<ul style="list-style-type: none"> <li>• 350 MB for the scanner driver</li> <li>• 1 to 2 GB for each additional application</li> </ul>	<ul style="list-style-type: none"> <li>• 350 MB for the scanner driver</li> <li>• 1 to 2 GB for each additional application</li> </ul>

## Documentation

### The following printed documentation is provided in the box:

- **Installation guide**—abbreviated scanner setup and installation instructions.
- **Technical support card**—contact information for technical support and customer service, and a brief overview of our standard product warranty.
- **Warranty card**—the warranty card is provided for users in Russia and should be filled in as described on the card. For all other users, please dispose of this card in paper recycling.

### The following soft-copy documentation is available on the installation disc:

- **Scanner user guide**—instructions for scanner setup, installation, operation, maintenance, safety, and warranty. The instructions in this guide cover how to properly use the scanner and perform maintenance. Please refer to your scanning application's user guide or help file for instructions on how to access the scanner's interface, scan and save files.
- **TWAIN scanning guide**—instructions for scanning using the TWAIN interface. This guide describes the options available in the TWAIN interface. Please refer to your scanning application's user guide or help file for instructions on how to access the scanner's interface, scan and save files.
- **Patch code sheets**—use with an application that supports detection of patch code data when using the TWAIN interface. The patch code page layouts have been specifically designed for your scanner. The file contains Patch 1 layouts for A4 and U.S. Letter size pages.

Make sure you print the correct page size for the paper in your printer. Also, make sure the application you are using is not set to automatically scale the page to fit on the paper in your printer.

## Xerox® Simplex Combo Scanner Features

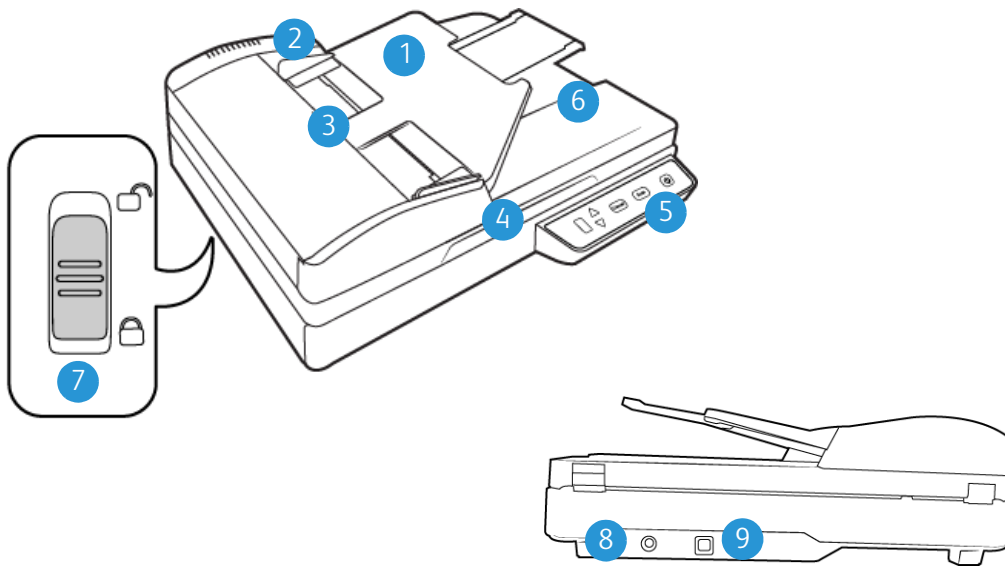

1. **Input Tray**—Holds the documents in the Automatic Document Feeder for scanning.
2. **Paper Guides**—Guides adjust to support various document widths.
3. **Automatic Document Feeder**—Feeds documents through the scanner during scanning.
4. **Scanner Lid**—Lift lid to place an item on the flatbed glass for scanning.
5. **Status light / Power Button**—Turns the scanner's power off and indicates the scanner's status.
6. **Output Tray**—Holds documents after being scanned through the Automatic Document Feeder.
7. **Lock**—Locks or unlocks the scanning head; located on the underside of the scanner.
8. **Power jack**—Connects the power cord to the scanner.
9. **Universal Serial Bus (USB) port**—Connects the scanner to the computer.



### 3. Assemble the Scanner

1. Remove the scanner from its protective foam and plastic bag.
2. Remove all shipping tape from the top and bottom of the scanner.

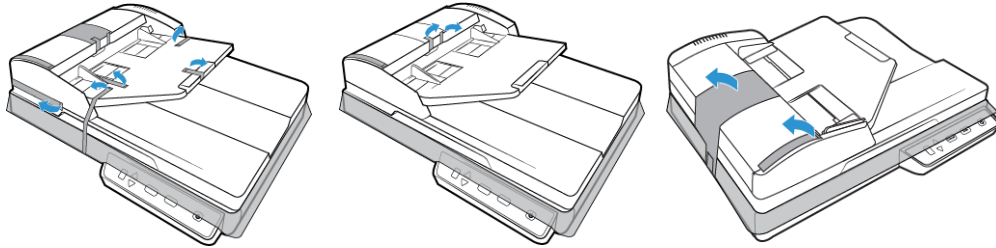

3. Lift the scanner lid. Remove any tape and protective foam from around or on the flatbed glass.

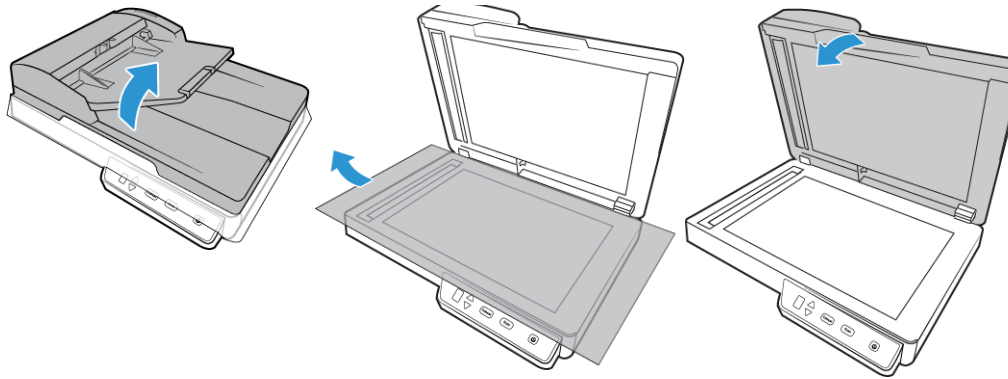

4. Open the automatic document feeder cover and remove any tape or protective foam from inside the feeder. Close the feeder cover when you are finished.

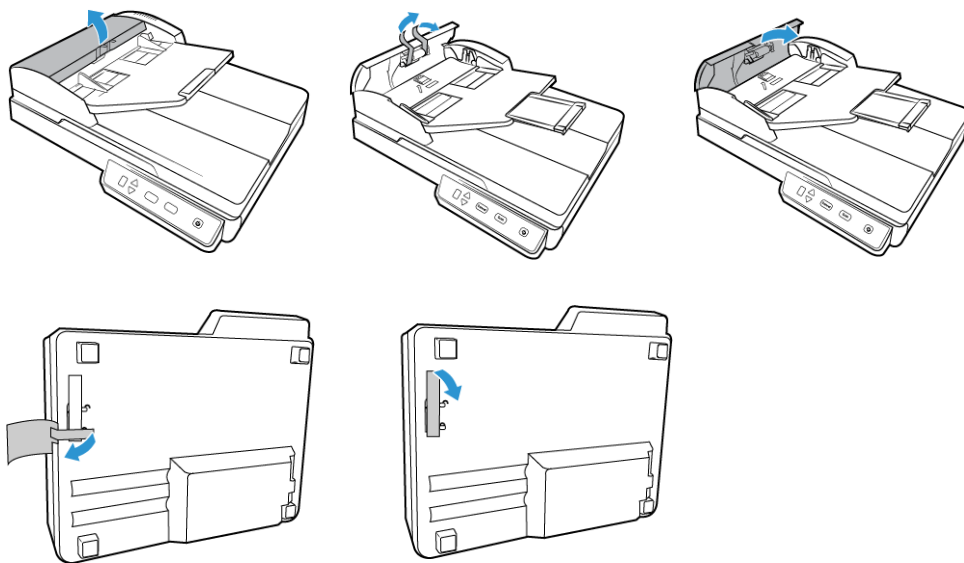

- Slide the locking tab on the bottom of the scanner to its unlocked position. The scanner will not scan when locked.

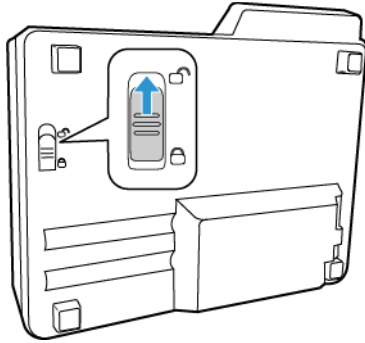

## Connect the Power Cord

**Note:** Only use the power supply (WA-36A24R made by APD) included with your scanner. Connecting any other type of power supply may damage your scanner, and will void its warranty.

### Assemble the power adapter:

- Select the power plug adapter that is appropriate for the wall outlet in your country.

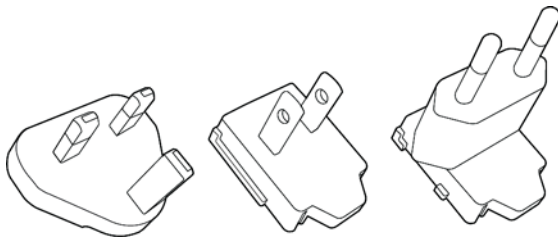

U.K., North America, Europe

- Slide the power plug adapter into the power supply base.

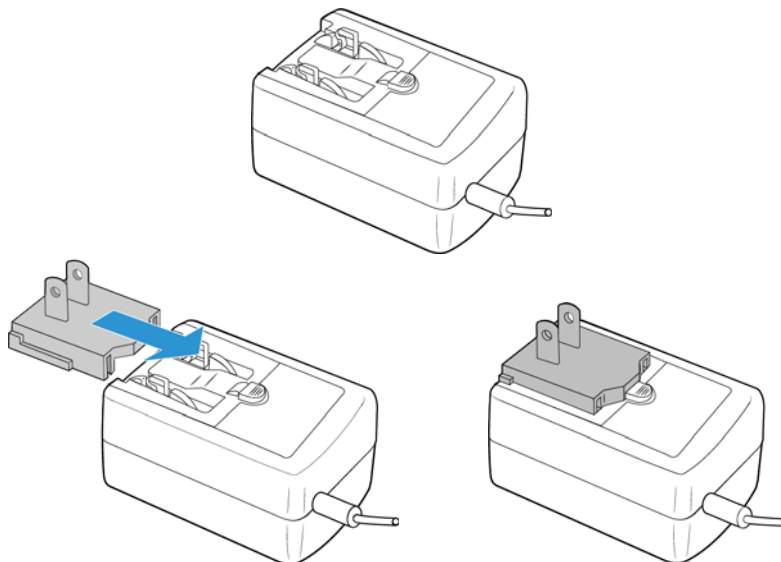

- Plug the power supply into the power port on the scanner.

4. Plug the power cord into the power supply and into a wall outlet.

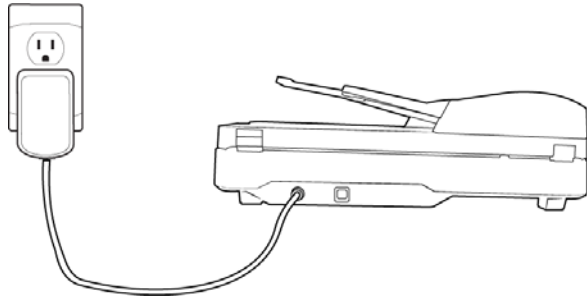





## 4. Installation

1. Insert the installation disc into your computer's DVD-ROM drive.

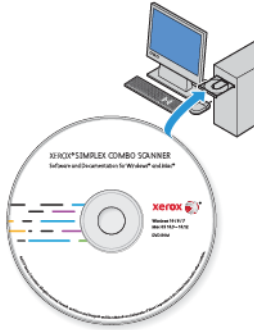

2. Double-click the disc icon that appears on the desktop.



3. Double-click the **Setup** file to start the driver installer.
4. The Select Language window opens. Click the drop-down menu arrow and select the language to use. Click **OK**.

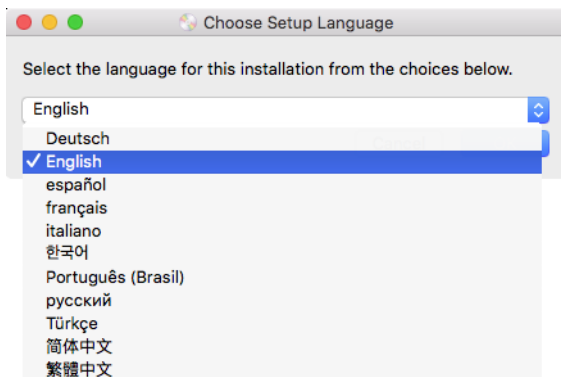

The disc's Main menu window opens.

**Note:** If the disc does not start, check the following:

- Make sure the disc drives door is completely shut.
  - Make sure the disc was inserted in the drive in the proper direction (label side up).
5. A prompt will be shown to allow the installer to search online for software updates. Select **No** to install the software on the disc only.

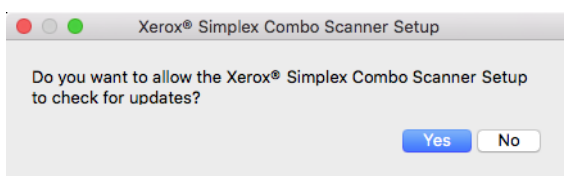

6. If online updates are approved, it will first check to see if there are newer versions of the installer.
7. Plug the USB cable into the USB port on the scanner then into a USB port on the computer. Turn on the scanner power.

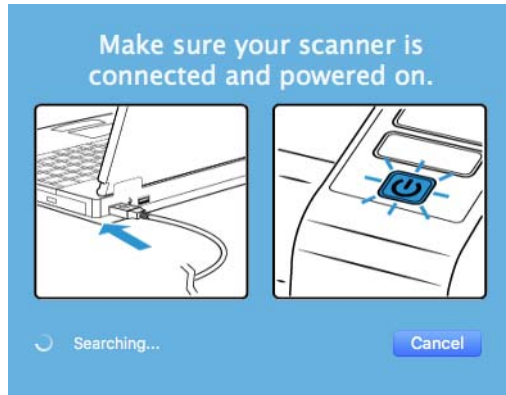

- Note:** Select **Cancel** to install the software on the disc only.
8. When this is complete, the Main Menu will be shown.
  9. On the Main menu, select **Install software**.

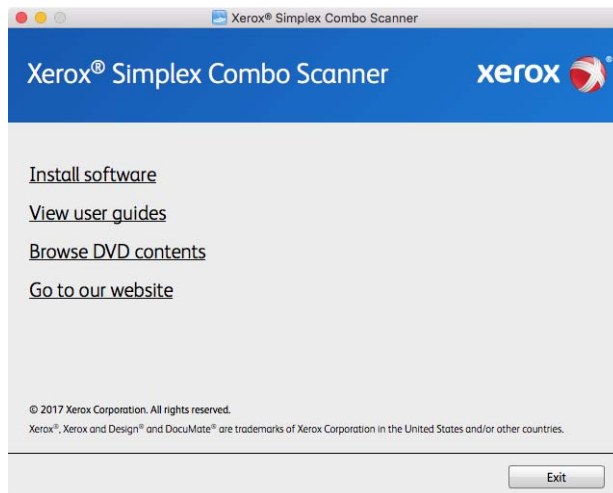

10. Make sure the boxes for **Scanner Driver** and **Visioneer Scan Utility** are selected, as well as any other applications you want to install.

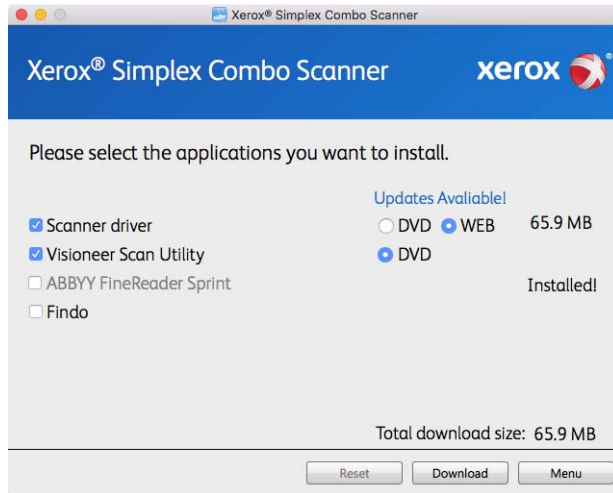

**Note:** The software provided with your scanner may differ slightly from the list shown in the window.

11. If a version of the software is already installed on the system, the option will be greyed out. However, if there is a newer version available on the disc or online, it will be possible to upgrade by selecting the appropriate button option.
12. If there are newer versions of the software available online, the **Web** button will be enabled. If there is no newer version then only the **DVD** button will be enabled.  
Select which option to install the software from.
13. If any of the Web buttons have been selected, the software will have to first be downloaded by clicking **Download** Now. The total size of the download is shown at the bottom.
14. After the download has begun, it can be paused. If changes to the selections are required, it is necessary to click **Reset** while the download is paused. This will allow the settings to be changed.

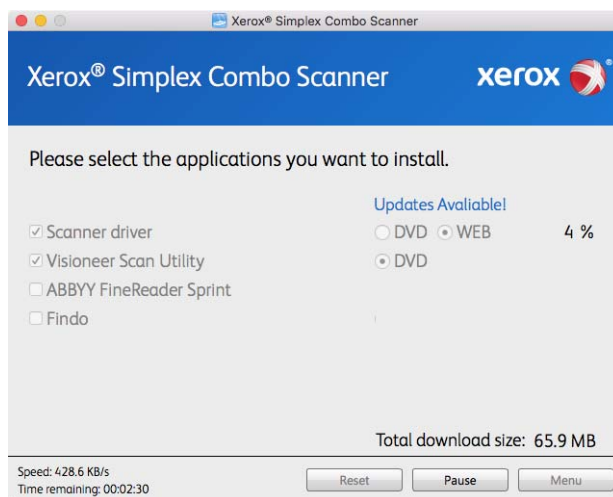

**Note:** Clicking the Reset button in either the Main menu or the Install menu will cause both partially completed and previously downloaded files to be deleted. In order to be installed they will either have to be downloaded again or installed from the DVD.

- Once all software has been downloaded, click **Install** now.

## Installing the Scanner Driver

The scanner driver installation will start first.

- Click **Continue**.

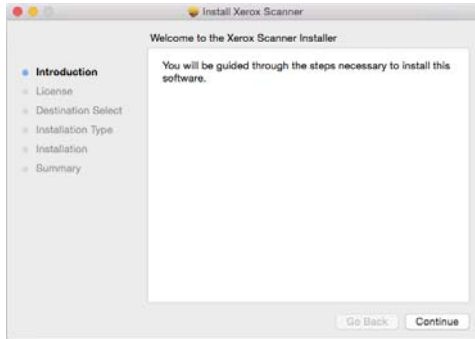

- On the Xerox License Agreement window, read the license agreement. Click **Continue**.

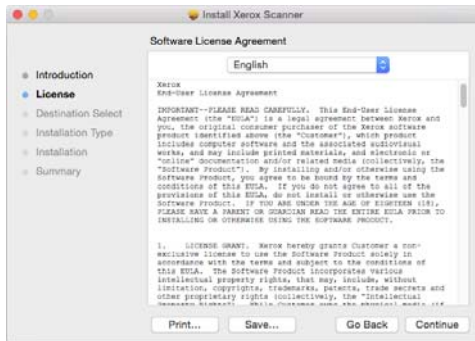

- If you accept the terms, select **Agree** and continue with the installation.

If you choose not to accept the license agreement, close the installation window. The scanner driver will not be installed.

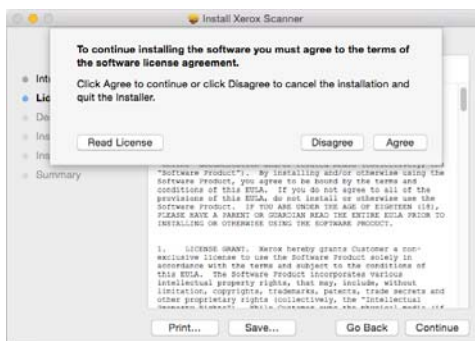

- Depending on your system configuration, you may be prompted to choose a location for the installation. We recommend that you select the main disc drive and click **Install**.

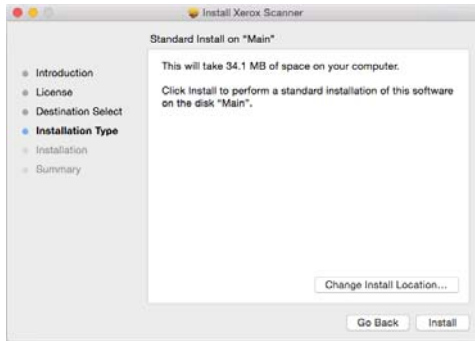

- If you are prompted for a password, input the name and password for a user that has permission to install software on your computer.



- Click **Close** on the installation complete window.  
You can now connect the scanner to your computer.

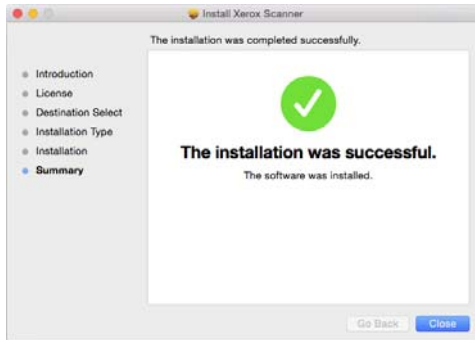

**Technical Note:** the Installation Complete screen may be blank when installing on OS X (10.9). Please close the empty screen and proceed with connecting the scanner to the computer.

### CONNECT THE USB CABLE AND TURN ON THE POWER

If you did not connect the scanner earlier, proceed with the instructions below.

1. Remove any tape from the USB cable.
2. Plug the USB cable into the USB port on the scanner then into a USB port on the computer. Check your computer's manual for USB port locations.

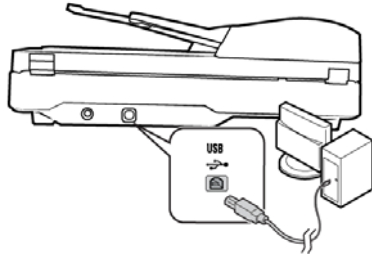

If the plug does not attach easily, make sure that you are plugging it in correctly. Do not force the plug into either connection.

3. Turn on the scanner power.

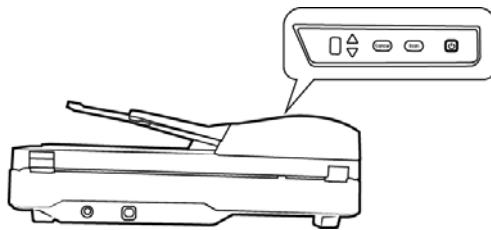

The status light comes on and flashes indicating that the scanner is receiving power.

Your computer recognizes that a scanner has been plugged into the USB port and automatically loads the appropriate software to run the scanner.

## Install the Visioneer Scan Utility

The **Visioneer Scan Utility** software installation will start automatically after you click **Close** on the driver Installation Complete window. Follow the instructions on the screen to install the application.

Software	About the Software
Visioneer Scan Utility	This utility uses the scanner's TWAIN interface for scanning. You can select a destination folder on your computer and save the image as any one of several popular image file formats (BMP, JPG, GIF, TIF, Multi-Page TIF, PDF, Multi-Page PDF).

## Installing Additional Applications

Your scanner includes free, additional applications as described in the table below.

1. Return to the disc's Main menu and click **Install software**.
2. If a version of the software is already installed on the system, the option will be greyed out. However, if there is a newer version available on the disc or online, it will be possible to upgrade by selecting the appropriate button option.

3. If the software on the disc is up to date then the software will be installed from the DVD. However, if there are newer versions of the software available online, the **Web** button will be shown and selected by default.

Select the desired location to install the software from.

4. If any of the Web buttons have been selected, the software will have to first be downloaded by clicking **Download Now**.
5. Once all software has been downloaded, click **Install now**.
6. Follow the instructions on the screen to install each of the additional applications.

## View the User Guides

1. Return to the disc's Main menu and click on **View user guides**.

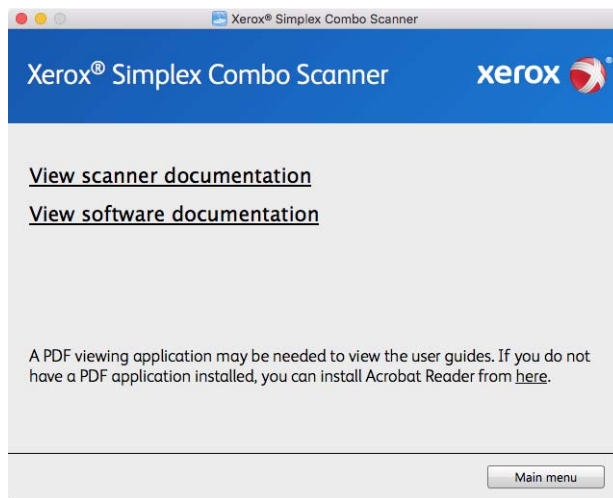

2. Click on **View scanner documentation** to access the scanner user guide and scanning guides for TWAIN.
  - **Scanner user guide**—Instructions for scanner setup, installation, operation, maintenance, safety, and warranty



- **TWAIN scanning guide**—Instructions for accessing and scanning using the TWAIN interface

Click on **View software documentation** to access the user guides for the software applications provided with the scanner.

From either of these user guide windows, click on the **User guide menu** button to return to the main user guide window, then select the other documentation section to view the user guides.

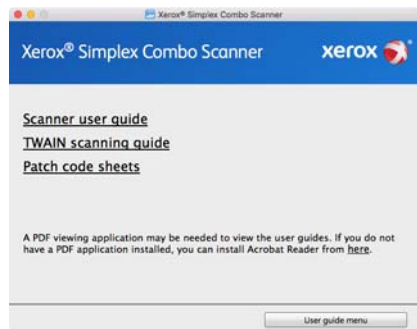

3. Click the links of the guides you want to view.
4. When you're finished, click **Main menu** to return to the Main menu window and click **Exit**.
5. Remove the installation disc and store it in a safe place.

## Register Your Scanner

Registering your scanner is important as it provides you with access to our free telephone support service. Registration also gives you free access to software updates for your scanner.

You will need an active internet connection to register your scanner. If you do not have internet access you can contact our customer service department to register the scanner. Please refer to the Technical Support Card, that you received with the scanner, for our customer service contact information.

1. Open **Safari** or any other Internet browser you have installed on your computer.
2. In the web address field type [www.xeroxscanners.com](http://www.xeroxscanners.com).
3. Press Enter on your computer's keyboard or click the option on screen to go to the web address.
4. When the Xerox® scanners web page loads click on **Register Your Product**.
5. Fill in the registration form, all required fields have an asterisk (\*).  
A valid email address is required for registration.
6. You will be asked to enter the serial number for the scanner, it is located on the back or underside of the scanner.
7. After filling in the form, click on **Submit Your Registration** to complete the registration.

## 5. Loading Documents to Scan

Always remove any staples or paper clips from documents before inserting them into the scanner. Staples and paper clips can jam the feed mechanism and scratch the internal components. Also remove any labels, stickers, or Post-It™ notes that may come off during the scanning process and get stuck in the scanner. Misuse as described here will void your scanner's warranty.

Please go to [www.xeroxscanners.com](http://www.xeroxscanners.com), select your product, and then click the "Warranty Program" link to view the warranty terms and conditions for your scanner.



### Scanning from the Automatic Document Feeder (ADF)

#### SUPPORTED DOCUMENT TYPES

You can scan the following types of documents and cards with this scanner.

- Maximum amount of paper in the input tray
  - Approximately 35 pages of 20 lb (75–80 g/m<sup>2</sup>) new printer paper
- Document size
  - Minimum size (width x length) – 3 x 5.9 inches (76 x 150 mm)
  - Maximum size (width x length) – 8.5 x 14 inches (215 x 356 mm)
  - Maximum length with long document enabled
    - 118 inches (2997 mm) up to 300dpi
    - 59 inches (1499mm) at 400dpi and higher

We recommend scanning one page at a time when the documents you are scanning are longer than 14 inches (356 mm).

- Valid mixed document size sets without long document enabled
  - Scanner minimum to maximum

Arrange the documents so that all items are centered in the stack. The document sensor, paper separation, and feed rollers are located in the middle of the paper path. If smaller items are offset from the center they will not be detected. This will cause feeding issues and paper jams.

- Paper thickness between 16–28 lb paper (60–105 g/m<sup>2</sup>)

#### DOCUMENTS TO AVOID SCANNING

The documents in this list can be scanned, but please note that scanning documents of this type will reduce the life of the scanner. Maintenance will be required more often and replaceable parts will wear faster. These types of documents will jam more frequently and damage to the original documents may occur. If you do choose to scan these document types, do not scan large batches. This type of use is not covered under the scanner warranty and alters replacement parts life expectancy.

We recommend you limit the amount or completely avoid scanning documents that are in this list.

- Curled, wrinkled or folded documents may cause paper jams or multiple pages being fed through the scanner at one time.
- Perforated or punched paper that could tear when the separation roller engages.
- Coated paper or photographs where the coating can flake off during scanning and leave residue in the scanner.
- Extremely smooth, shiny, or highly textured paper may cause the paper feed rollers to slip across the page and cause the scanner to report a paper jam.
- Carbonless copy paper may tear while being fed through the scanner and the pressure of the rollers may leave streaks on the page. The chemical coating on this paper will rub off on the rollers during the scan process, increasing the frequency of miss-feeds and paper jams.
- Partially transparent paper such as tracing paper as any images from the opposite side of the page or black background will appear in the scanned images.

#### UNSUPPORTED DOCUMENT TYPES

Do not scan the following types of documents as they may cause damage to the scanner.

- Items outside of the specified supported sizes, thickness, and weight defined in this document.
- Non-rectangular or irregularly shaped paper will cause the scanner to detect and report document skew errors or paper jams.
- Carbon paper that will leave residue in the scanner and on the rollers that will transfer to the next set of documents scanned.
- Documents with hard items attached such as paper clips, binder clips, and staples.
- Documents with wet ink or white-out.
- Thermal or photosensitive paper.
- Overhead projector sheets, plastic film, camera film, and any other type of transparent or partially transparent plastic item.
- Documents that have been glued together.
- Cloth or metallic sheets.

#### PREPARING DOCUMENTS FOR SCANNING

- Fan the documents to make sure all pages in the stack are separated.



- Bend and then flatten the document stack to make sure the horizontal edges are aligned to help prevent paper from skewing while being pulled through the scanner.



- Pinch the ends to align the leading edges slantwise to help prevent multiple pages from being fed through at a single time.



#### LOADING DOCUMENTS

1. Adjust the paper guides for the width of the documents being scanned. If needed, pull out the input tray extension and flip up the paper stop.

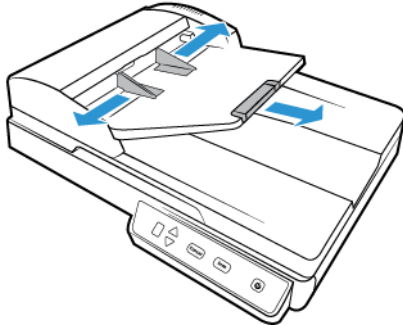

2. Load the documents *face up* with their tops into the Automatic Document Feeder.

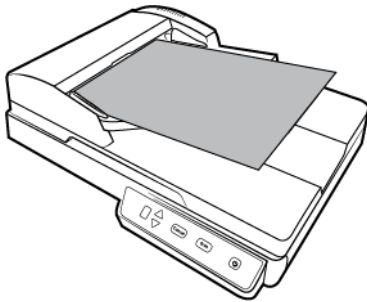

## Scanning from the Flatbed Glass

#### SUPPORTED DOCUMENT TYPES

You can scan the following types of documents with this scanner.

- Document size
  - Minimum size (width x length) – 0.5 x 0.5 inches (13 x 13 mm)
  - Maximum size (width x length) – 8.5 x 11.70 inches (216 x 297 mm)

#### LOADING DOCUMENTS

Use the Flatbed glass to scan documents on light weight paper, such as credit card receipts, or items that cannot be scanned with the Automatic Document Feeder, such as pages in a book or plastic cards.

**Note:** You must remove any pages from the Automatic Document Feeder before scanning from the Flatbed glass. If pages are in the Automatic Document Feeder, they will be scanned instead of the page on the Flatbed glass.

1. Open the scanner lid and place the page on the scanner glass, *face down*.
2. Align the item with the arrow on the reference frame then close the cover.

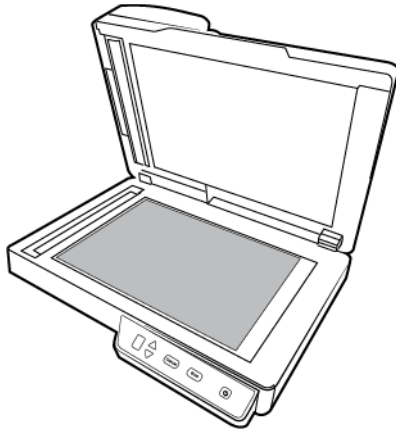

## Scanning Interfaces

Every scanning application will access the scanner using a different method. Please refer to the application's user guide for instructions on using the application and accessing the scanner.

- **TWAIN Interface**—TWAIN is a widely recognized standard that computers use to receive images from scanners and digital cameras. The TWAIN scanning interface can be accessed from any TWAIN scanning application you have installed on the computer.

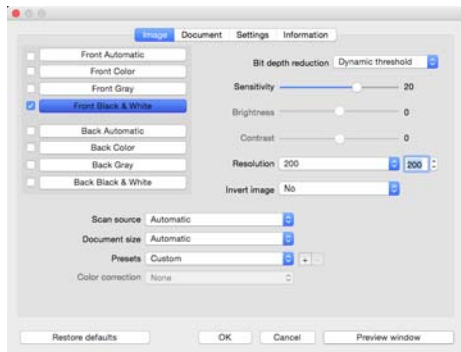

- **ICA Interface**—the ICA driver has been developed to enable image transfer from devices using standard Mac applications, such as Image Capture, without the need to install additional scanning software.



## 6. Maintenance

This section contains information about maintenance, troubleshooting, uninstalling, scanner specifications, and spare parts.

### Safety Precautions

When servicing the scanner you should take the following precautions to ensure your safety and prevent damage to the scanner.

#### Do These

- Wear protective gloves when cleaning the scanner with Isopropyl rubbing alcohol. Rubbing alcohol may irritate sensitive skin.
- Only perform scanner maintenance as described in this chapter.
- Keep the scanner and cleaning supplies away from any open flame or heat source as any form of alcohol is flammable.
- Always read the instructions in each section carefully, the instructions are specific to the part you are installing or servicing.
- Move the scanner to an area that has adequate room for opening the scanner.
- If your scanner has a power cord and/or power switch, always turn off the scanner and unplug the power cord before performing maintenance, unless the maintenance instructions below specifically state to leave the scanner plugged in and powered on.
- Always unplug the USB cable from the scanner before performing maintenance, unless the maintenance instructions below specifically state to leave the scanner plugged in.
- Wear an anti-static strap to prevent electrostatic discharge when touching metal components.
- Keep all cleaning supplies, scanner parts and accessories out of the reach of children.

#### Do Not Do These

- Never attempt installation of any part not described in this manual.
- Never service the scanner near a radiator or any other heat source.
- Never use aerosol sprays or compressed air, or attempt to lubricate parts with an oil or silicon spray.
- Never service the scanner in an area where there are open liquid containers.
- Never pour or spill liquid on the scanner or any of its components.

## Clearing Paper Jams

If your scanner stops scanning due to a paper jam in the Automatic Document Feeder, a warning opens after a few moments.

1. Open the Automatic Document Feeder cover.

Do not attempt to remove a jammed page with the scanner closed.

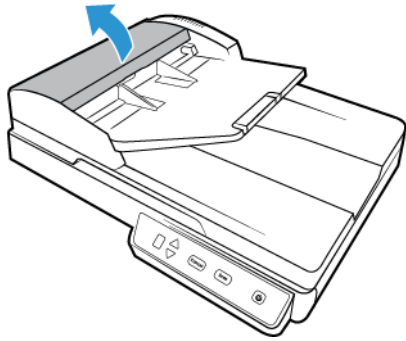

2. Remove the jammed page from the scanner.

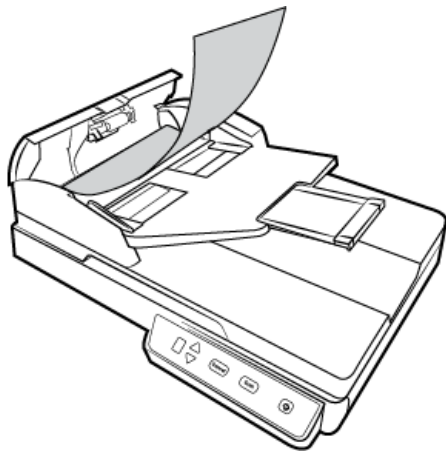

3. Close the ADF cover. Carefully press down on the ADF cover until it locks in place with a “click”.

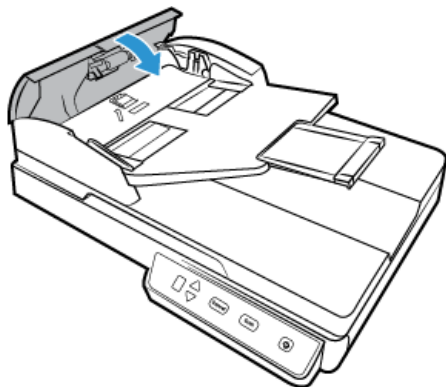

To reduce the number of paper jams, smooth and straighten the paper before scanning, adjust the guides to the paper size, and insert the paper evenly into the ADF.

## Cleaning the Scanner

Regular maintenance of your scanner can help to ensure continual optimal performance.

Using a soft, lint-free cloth, wipe down all plastic surfaces on the scanner.

### CLEANING INSIDE THE AUTOMATIC DOCUMENT FEEDER

Cleaning the inside of the scanner helps to keep your scanner operating at optimum performance. You should clean the inside of the scanner at least once a week or after 1,000 pages have been scanned. If you are getting frequent paper jams, multiple pages feeding at the same time, or you're seeing lines in the scanned image, it is time to clean the scanner.

**Note:** Be careful when cleaning the rollers. All of the rollers, except the free rollers, are designed to rotate in one direction only. Do not force the roller to rotate in the opposite direction. Forcing the roller to rotate will damage it, and cause the scanner to feed pages incorrectly.

1. Wet a soft cloth with some Isopropyl rubbing alcohol (70%).
2. Open the Automatic Document Feeder cover.

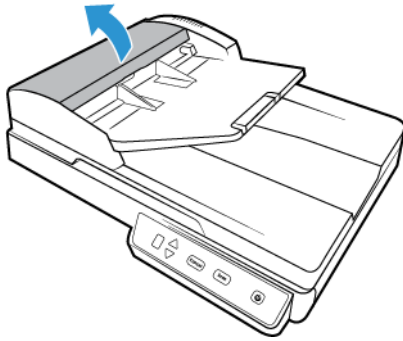

3. Wipe the feed roller from side to side. Rotate the roller to clean its entire surface.

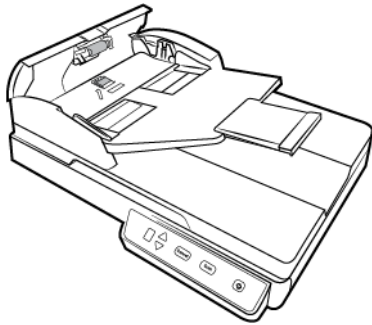



4. Close the ADF cover. Carefully press down on the ADF cover until it locks in place with a “click”

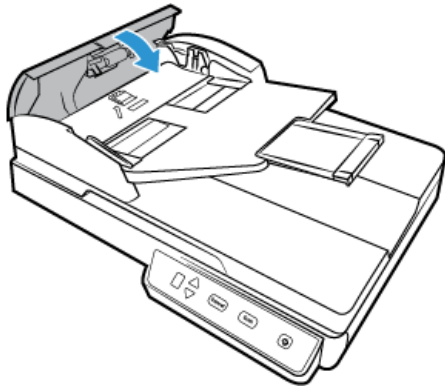

5. Wipe clean the glass strip in the body of the scanner.

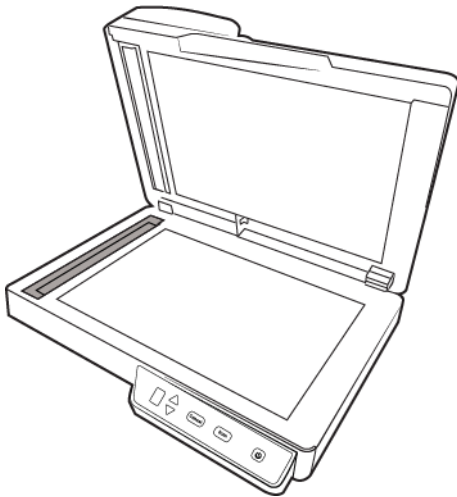

#### **CLEANING THE SCANNER GLASS**

Scanning items that have excessive amounts of dirt or dust may dirty the glass. To ensure the best quality scanned item, wipe the scanner glass with a soft, dry, clean cloth to rid the glass of dust or other debris.

If any residue remains after wiping the glass with a dry cloth, try adding a few drops of Isopropyl alcohol (rubbing alcohol) to the cloth and wipe off the residue.



## Replacing the ADF Pad Assembly

Problems with documents feeding into the ADF is an indication that the pad is wearing thin. The usage life of the ADF pad varies by what type of documents are generally scanned. Scanning large batches of heavily textured paper and embossed plastic cards will cause the ADF pad to wear faster. Large continuous batch scanning will also cause the ADF pad to wear faster. The ADF pad can be used to scan up to 30,000 pages.

You received a replacement pad in the original scanner box, you can also order a new one. Replacement parts can be purchased from the Parts & Accessories page for your scanner at [www.xeroxscanners.com](http://www.xeroxscanners.com).

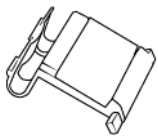

### To replace the ADF Pad:

1. Open the Automatic Document Feeder cover.

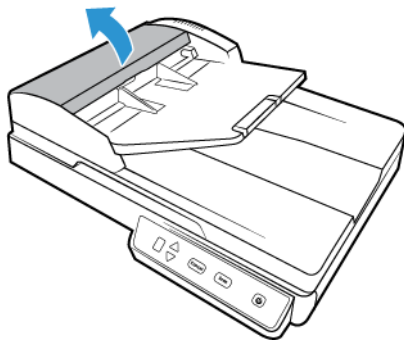

2. Squeeze the plastic clamp that holds the pad assembly in place.

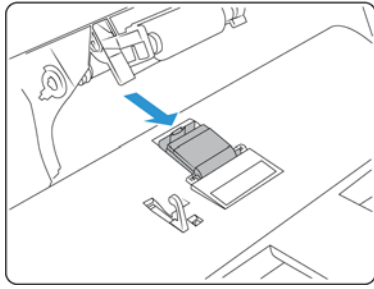

3. Rotate the ADF pad until it is able to slide free.

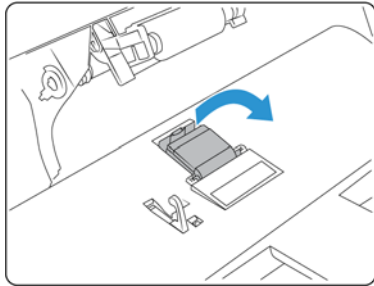

4. Lift the pad up and out of the scanner.

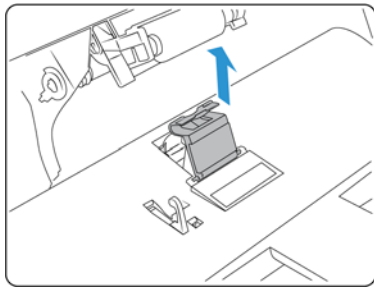

5. Remove the tensions spring that is located under the ADF pad.

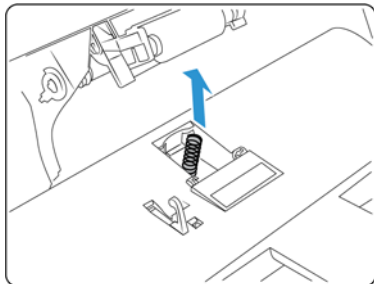

- Place the new tension spring in the scanner.

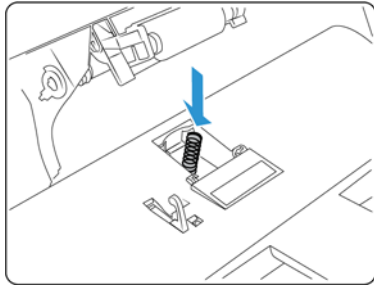

- Place the new ADF pad in the scanner and rotate it back into place.

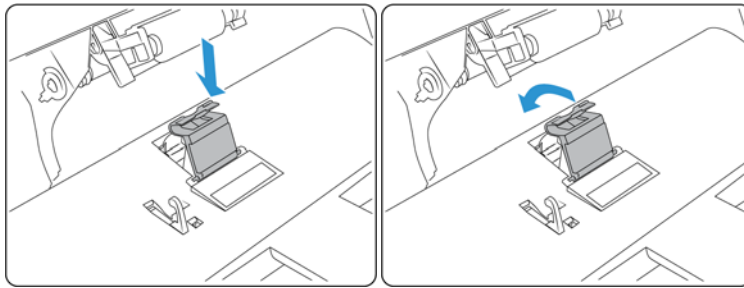

- Press down on the ADF pad until you hear a "click" when it locks in place.
- Close the scanner when you're finished.

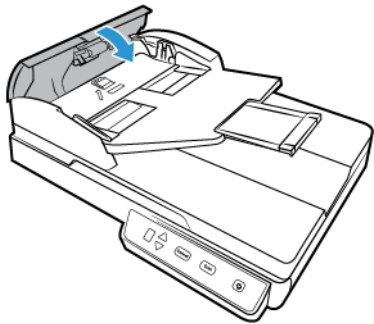

## Troubleshooting

**Problem:** The scanner won't scan. What's wrong?

Check for one of these possible causes:

- **Are the cables loose or not plugged in securely?** Inspect the cable connections. Make sure the cables are plugged in securely.
- **Is the scanner's status light on?** Turn on the scanner's power. If the status light doesn't come on, plug the power supply into another electrical outlet. If you are using a UPS battery back-up or power strip, try plugging the scanner directly to a wall outlet.
- **Did you restart the computer and scanner?** If the scanner gets a paper jam, or loses connection because of an error, try restarting your computer and power cycling the scanner.

- **Did you plug the scanner into a USB hub?** If you're using a USB hub to connect the scanner try plugging the scanner's USB cable directly to the back of the computer. It is not recommended that you use the scanner with a USB hub, if you are using a hub, the hub must have its own power supply.
- **Is the USB cable 6' or less?** If you are using a USB cable that is longer than 6' you may lose connection to the scanner. The recommended USB cable length is 6' or less, the USB cable provided with your scanner is within this range.
- **Did you select another image source in the scanning software?** If you use multiple imaging devices with your computer, such as a camera, all-in-one printer, or another scanner, you may have selected another source for images. Make sure Xerox® Simplex Combo Scanner is selected as the scanner.

**Problem:** My computer keeps giving me out of hard drive space error messages.

The minimum requirement of free hard drive space is for the installation of the scanner driver and basic, low resolution, scanning. High resolution scans result in files that can be over 1 gigabyte in size. Free up some space on your hard drive for the software to be able to save the scanned images.

**Problem:** The paper jams the ADF.

To reduce the number of paper jams, smooth and straighten the paper before scanning, and adjust the guides to the paper size. Paper fed into the ADF at an angle can cause the feed mechanism to jam. If paper jams are occurring more frequently, try cleaning the roller with a soft cloth dampened with Isopropyl rubbing alcohol. Excessive dust on the roller can make it appear worn and will cause issues feeding paper. See "Cleaning Inside the Automatic Document Feeder" on page 3 for cleaning instructions.

**Problem:** The ADF won't feed pages properly.

A dirty or worn ADF pad assembly or dirt on the roller can cause documents to feed in skewed at an angle, or multiple pages to feed at the same time. Try cleaning the roller first. See "Cleaning Inside the Automatic Document Feeder" on page 3. If that doesn't solve the problem, the pad assembly may need to be replaced. It is user replaceable. See "Replacing the ADF Pad Assembly" on page 5 for the steps to replace the pad.

**Problem:** If the USB cable is disconnected during a scan, the scanner does not reconnect when the USB cable is plugged back in.

Unplug the power cable from the scanner, and then plug it back in.

If the scanner does not reconnect:

1. Unplug the power cable from the scanner.
2. Restart your computer.
3. After the restart is complete, plug the power cable back in.

**Problem:** The scans from the ADF are always crooked.

Make sure to align the paper guides to the edges of the paper. If you are scanning small items that are smaller than the paper guides' minimum adjustment, scan these items on the Flatbed glass instead.

**Problem:** The paper jams about halfway through the scan.

Check the flatbed glass to make sure no items are on it when you scan from the ADF. Multiple items placed on the Flatbed glass will raise the lid slightly. When that occurs, the pages are unable to feed back out of the ADF and the pages can jam.

**Problem:** My computer keeps giving me out of memory error messages.

An “Out of memory” message may appear when scanning long pages at higher resolutions. This error is most often seen on older versions of Mac OS X, due to the large file size created when scanning long pages in color or grayscale at 300 dpi or higher. If you see an out of memory error message, please try adjusting the page length and/or scan resolution.

**Problem:** Images are corrupted when scanning and saving as a GIF file format.

This is a known issue when using older versions of OS X, at this time the issue has been seen on 10.6 and 10.7 but you may see this problem on other versions of OS X as well. Please use a different file format when scanning if you are seeing corrupted image.

#### ERROR LIGHT TROUBLESHOOTING CODES

##### Normal Operation

- **Steady blue:** indicates the scanner is ready to scan.
- **Slow flashing blue:** indicates the scanner is in low power mode.
- **Rapid flashing blue:** indicates the scanner is waking up from low power mode.
- **Steady red:** the scanner is busy.
- **Flashing red:** the scanner is reporting an error.

##### Error Codes

The status light indicates the current state of the scanner. If your scanner experiences hardware problems, the status light turns red and will flash a specific number of times, pause, and then repeat the same number of flashes. The number of flashes between pauses indicates the hardware error code. The LED display will also flash an “E” then the error code number that matches the status light’s blinking pattern.

Descriptions of the most common patterns are listed below. In all cases, you should turn off the scanner and check the scanner setup. Make sure the USB cable is plugged into the scanner and computer. Make sure the power cord is plugged into the scanner and into a wall outlet. Contact Xerox Technical Support if you experience a different blinking pattern.

Error Code	Problem Description	Solution
0	Scanner is not connected to the computer (The LED does not flash “E” and the status light remains blue.)	A cable may be loose. Check that the scanner’s cables are correctly attached to the computer. If the scanner still does not connect, re-boot the computer.
3	The scanner was locked when you tried to scan.	Turn off the scanner, slide the locking tab to the unlocked position, then turn the scanner back on. See page 3 for the lock’s location. If the problem persists, reboot your computer.



Error Code	Problem Description	Solution
4	Paper jam	Open the ADF cover and remove the jammed page. See “Clearing Paper Jams” on page 2.
6	The scanner’s cover is open	The ADF door is not closed all the way. Open the scanner then close it again. Push down on the lid until it locks into place.
1, 2, 7 or 8	The lamp in the scanner body or lid has malfunctioned	This usually occurs if the power was disconnected during a scan. Turn the scanner off, then back on again. If the problem persists, turn off the scanner, re-start the computer, then turn the scanner on. If the problem continues, and your scanner’s power is plugged into a surge protector or UPS battery backup, try plugging the scanner power directly into a wall outlet.
All Other Codes	An internal part in the scanner may have malfunctioned	Turn off the power to your scanner, then turn it back on. If the problem persists, re-boot your computer. If the problem still persists, contact Xerox Technical Support.

## Xerox® Simplex Combo Scanner Specifications

Scanner Specifications	
<b>Document Requirements (ADF)</b>	
Minimum Item Size	3 x 5.9 inches (76 x 150 mm)
Maximum Item Size	8.5 x 14 inches (216 x 356mm)
Capacity	35 pages of 20lb printer paper (75–80 gsm)
Paper Thickness	16–28 lbs. (60–125 gsm)
<b>Document Requirements (Flatbed)</b>	
Minimum Item Size	0.5 x 0.5 inches (13 x 13 mm)
Maximum Item Size	8.5 x 11.70 inches (216 x 297 mm)
Item Thickness	0.39 inch (10 mm)
<b>General Specifications</b>	
Scanning Speed (ADF) • A4 Document Size	25 pages per minute @ 300dpi
Scanning Speed (Flatbed) • A4 Document Size	5 seconds per page @ 300 dpi
Optical Resolution	600 dpi
Output Bit Depth	24-bit color, 8-bit grayscale, 1-bit bitonal (black & white)
Scan Method	Simplex Automatic Document Feeder (ADF) Simplex U.S. Letter / A4 Flatbed
Image Sensor	CIS (Contact Image Sensor)
Light Source	RGB LED lamp
Interface	Hi-Speed USB 2.0, compatible with USB 1.1
Certifications	UL/C-UL, FCC Class B, CE, CB, WEEE, RoHS, ENERGY STAR, Mexico Energy (CFE), RCM, USB-IF, CCC
Operating Temperature	40° ~ 95° F (5° ~ 35° C without condensation)

Scanner Specifications	
Relative Humidity	10% ~ 90%
Scanner Dimensions	
Width	16 inches (405 mm)
Depth	13 inches (331 mm)
Height	5.6 inches (142 mm)
Weight	5.94 pounds (2.7 kg)
Power Information	
Power Supply	APD (WA-36A24R) DC Jack, 2P, 100~240Vac, 24Vdc, 1.5A, 36W, Class 1, ENERGY STAR, RoHS
Scanner Rating	24Vdc, 1.5A
Power consumption	≤ 15 Watts (during operation) ≤ 6.0 Watts (on standby) < 2.0 Watts (power save after 15 minutes without scanning) ≤ 0.5 Watt (power off)
Cable Information	
USB cable	1850 mm, 28AWG, with core, RoHS compliant
Software Information	
Supported Operating Systems	Apple® Mac OS X®
Scanner Drivers	TWAIN, ICA
Bundled Software	Visioneer® Scan Utility

## Xerox® Simplex Combo Scanner Parts List

Part Name	Part Number	
ADF Pad	57-0156-000	
USB Cable	35-0118-000	
Power Supply Power Adapter Plugs	37-0100-000	





## 7. Appendix A: Regulatory Information

### Basic Regulations

#### UNITED STATES (FCC REGULATIONS)



This equipment has been tested and found to comply with the limits for a Class B digital device, pursuant to Part 15 of the FCC Rules. These limits are designed to provide reasonable protection against harmful interference in a residential installation. This equipment generates, uses, and can radiate radio frequency energy and, if not installed and used in accordance with the instruction manual, may cause harmful interference to radio communications.

However, there is no guarantee that interference will not occur in a particular installation. If this equipment does cause harmful interference to radio or television reception, which can be determined by turning the equipment off and on, the user is encouraged to try to correct the interference by one or more of the following measures:

- Reorient or relocate the receiving antenna.
- Increase the separation between the equipment and receiver.
- Connect the equipment into an outlet on a circuit different from that to which the receiver is connected.
- Consult the dealer or an experienced radio/TV technician for help.

This device complies with Part 15 of the FCC Rules. Operation is subject to the following two conditions: (1) This device may not cause harmful interference, and (2) this device must accept any interference received, including interference that may cause undesired operation.

Changes and modifications to this equipment not specifically approved by Xerox® may void the user's authority to operate this equipment.

Shielded cables must be used with this equipment to maintain compliance with FCC regulations.

#### EUROPEAN UNION

The CE mark applied to this product, symbolizes our declaration of conformity with the following applicable European Union Directives, as of the dates indicated:



September 8, 2017:	Council Directive 2014/35/EU as amended. Approximation of the laws of the member states related to low voltage equipment.
August 12, 2016:	Council Directive 2014/30/EU as amended. Approximation of the laws of the member states related to electromagnetic compatibility.

This machine is certified as Class 1 LED product. This means that this machine does not produce hazardous laser radiation.

A full declaration of conformity, defining the relevant directives and referenced standards, can be obtained from your Xerox Limited representative or by contacting:

Environment, Health and Safety  
 Xerox Corporation  
 Oxford Road  
 Uxbridge  
 UBS 1HE  
 Telephone 1-800-ASK-XEROX

**TURKEY (ROHS REGULATION)**

In compliance with Article 7 (d) We hereby certify “It is in compliance with the EEE Regulation”.  
 (“EEE yönetmeliğine uygundur”)

**Copy Regulations**

**UNITED STATES**

Congress, by statute, has forbidden the reproduction of the following subjects under certain circumstances. Penalties of fine or imprisonment may be imposed on those guilty of making such reproductions.

1. Obligations or Securities of the United States Government, such as:

Certificates of Indebtedness	National Bank Currency	Coupons from Bonds
Federal Reserve Bank Notes	Silver Certificates	Gold Certificates
United States Bonds	Treasury Notes	Federal Reserve Notes
Fractional Notes	Certificates of Deposit	Paper Money

Bonds and Obligations of certain agencies of the government, such as FHA, etc.

Bonds. (U.S. Savings Bonds may be photographed only for publicity purposes in connection with the campaign for the sale of such bonds.)

Internal Revenue Stamps. (If it is necessary to reproduce a legal document on which there is a canceled revenue stamp, this may be done provided the reproduction of the document is performed for lawful purposes.)

Postage Stamps, canceled or uncanceled. (For philatelic purposes, Postage Stamps may be photographed, provided the reproduction is in black and white and is less than 75% or more than 150% of the linear dimensions of the original.)

Postal Money Orders.

Bills, Checks, or Drafts of money drawn by or upon authorized officers of the United States.

Stamps and other representatives of value, of whatever denomination, which have been or may be issued under any Act of Congress.

2. Adjusted Compensation Certificates for Veterans of the World Wars.
3. Obligations or Securities of any Foreign Government, Bank, or Corporation.

4. Copyrighted material, unless permission of the copyright owner has been obtained or the reproduction falls within the “fair use” or library reproduction rights provisions of the copyright law. Further information of these provisions may be obtained from the Copyright Office, Library of Congress, Washington, D.C. 20559. Ask for Circular R21.
5. Certificates of Citizenship or Naturalization. (Foreign Naturalization Certificates may be photographed.)
6. Passports. (Foreign Passports may be photographed.)
7. Immigration Papers.
8. Draft Registration Cards.
9. Selective Service Induction Papers that bear any of the following Registrant’s information:

Earnings or Income	Dependency Status	Court Record
Previous military service	Physical or mental condition	

Exception: U. S. Army and Navy discharge certificates may be photographed.

10. Badges, Identification Cards, Passes, or Insignia carried by military personnel, or by members of the various Federal Departments, such as FBI, Treasury, etc. (unless photograph is ordered by the head of such department or bureau.)
11. Reproducing the following is also prohibited in certain states: Automobile Licenses — Drivers’ Licenses — Automobile Certificates of Title.

The above list is not all inclusive, and no liability is assumed for its completeness or accuracy. In case of doubt, consult your attorney.

#### CANADA

Parliament, by statute, has forbidden the reproduction of the following subjects under certain circumstances. Penalties of fines or imprisonment may be imposed on those guilty of making such copies.

1. Current bank notes or current paper money.
2. Obligations or securities of a government or bank.
3. Exchequer bill paper or revenue paper.
4. The public seal of Canada or of a province, or the seal of a public body or authority in Canada, or of a court of law.
5. Proclamations, orders, regulations or appointments, or notices thereof (with intent to falsely cause same to purport to have been printed by the Queen’s Printer for Canada, or the equivalent printer for a province).
6. Marks, brands, seals, wrappers or designs used by or on behalf of the Government of Canada or of a province, the government of a state other than Canada or a department, board, Commission or agency established by the Government of Canada or of a province or of a government of a state other than Canada.
7. Impressed or adhesive stamps used for the purpose of revenue by the Government of Canada or of a province or by the government of a state other than Canada.

8. Documents, registers or records kept by public officials charged with the duty of making or issuing certified copies thereof, where the reproduction falsely purports to be a certified copy thereof.
9. Copyrighted material or trademarks of any manner or kind without the consent of the copyright or trademark owner.

The above list is provided for your convenience and assistance, but it is not all inclusive, and no liability is assumed for its completeness or accuracy. In case of doubt, consult your solicitor.

#### OTHER COUNTRIES

Copying certain documents may be illegal in your country. Penalties of fine or imprisonment may be imposed on those found guilty of making such reproductions.

- Currency notes
- Bank notes and cheques
- Bank and government bonds and securities
- Passports and identification cards
- Copyright material or trademarks without the consent of the owner
- Postage stamps and other negotiable instruments

**Note:** this list is not inclusive and no liability is assumed for either its completeness or accuracy. In case of doubt, contact your legal counsel.

## 8. Appendix B: Compliance Information

### Product Recycling & Disposal

#### USA & CANADA

If you are managing the disposal of your Xerox® product, please note that the product may contain lead, mercury, Perchlorate, and other materials whose disposal may be regulated due to environmental considerations. The presence of these materials is fully consistent with global regulations applicable at the time that the product was placed on the market. For recycling and disposal information, contact your local authorities. In the United States, you may also refer to the Electronic Industries Alliance web site: <http://www.eiae.org>.

Perchlorate Material - This product may contain one or more Perchlorate-containing devices, such as batteries. Special handling may apply, please see: <http://www.dtsc.ca.gov/hazardouswaste/perchlorate/>.

#### EUROPEAN UNION

##### RoHS and WEEE Compliance

This product is compliant with RoHS Regulations of the European Parliament and Council Directive on the Restrictions of the Use of Certain Hazardous Substances in Electrical and Electronic Equipment (2011/65/EU), and with the Waste Electrical and Electronic Equipment (WEEE) Directive (2012/19/EU).

Some equipment may be used in both a domestic/household and a professional/business application.

##### Professional/Business Environment

Application of this symbol on your equipment is confirmation that you must dispose of this equipment in compliance with agreed national procedures. In accordance with European legislation, end of life electrical and electronic equipment subject to disposal must be managed within agreed procedures.



### ENERGY STAR for the USA

#### Energy Program Compliance

The Xerox® Simplex Combo Scanner is ENERGY STAR qualified under the ENERGY STAR Program Requirements for Imaging Equipment.



The ENERGY STAR and ENERGY STAR MARK are registered United States trademarks. The ENERGY STAR Imaging Equipment Program is a team effort between U.S., European Union and Japanese governments and the office equipment industry to promote energy-efficient copiers, printers, fax, multifunction machine, personal computers, and monitors. Reducing product energy consumption helps combat smog, acid rain and long-term changes to the climate by decreasing the emissions that result from generating electricity.

Xerox® equipment is preset at the factory. Your machine will be delivered with the timer for switching to Power Save Mode from the last scan set at 15 minutes.

